

# OPERATING INSTRUCTIONS: Bottle Cooler & Glass Froster

V3/2018

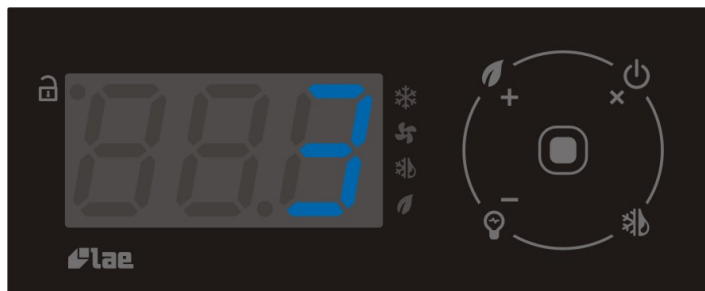

*This page is intentionally left blank*

## Contents

|  |          |
|--|----------|
| General Hazards  | 4        |
| Electrical Connection  | 4        |
| Unpacking  | 4        |
| Installation   | 4        |
| Ventilation  | 4        |
| Shelves  | 5        |
| Castors / Adjustable Legs / Levelling Feet                     | 5        |
| <b>Initial Start Up</b>  | <b>6</b> |
| Checks   | 6        |
| Using Your New Piece of Refrigeration Equipment                | 6        |
| <b>Commissioning Instructions</b>                              | <b>7</b> |
| Bottle Coolers +3°C to +15°C                                   | 7        |
| Glass Frosters -18°C to -20°C                                  | 7        |
| <b>Maintenance and Cleaning: Condenser, Gasket Replacement</b> | <b>8</b> |
| End of Life Disposal Requirements                              | 8        |
| <b>Fault Finding: Alarms</b>                                   | <b>9</b> |
| Wiring Diagram   | 10       |
| Notes  | 11       |

All information is subject to change without prior notice.

## General Hazards

All moving parts of the refrigerator are suitably guarded, and the moving parts can only be accessed by using tools which should only be attempted by a qualified person.

## Electrical Connection

This product is supplied with a moulded plug which needs a suitable socket. This cabinet should not be used outside and should be used in a dry environment. The plug needs to be accessible once the equipment is placed in its final position. Should the plug need changing, this must be done by a qualified person.



## Unpacking

Leave all packaging in place until refrigerator is in its final position to avoid damage. When the cabinet is in its final position, carefully remove all packaging and check for damage. Any damage should be reported immediately to your dealer. All packaging should be carefully disposed of and recycled where possible.

## Installation

The cabinet is very easy to move around as most precision products are supplied on castors. If for any reason the cabinet has to be laid down, it should always be laid on its back and not its side or front to avoid damage. When lowering or raising the cabinet extreme care should be taken as the castors can run away whilst lifting or lowering. A person should always be standing at the base of the cabinet whilst it is being lowered or raised. Cabinet should not be plugged in for at least 4 hours if it has been laid down or tipped during installation.

This product must be placed on a level floor to ensure the automatic door closing and correct draining of condensate. This is especially important with freezers.

## Ventilation

Refrigeration equipment generates a lot of heat. A 2-door freezer cabinet for example gives off the same heat as a 1kW electric heater. Therefore, it is very important that the cabinet must be installed with sufficient space around it for ventilation and for maintenance access. Ventilation grills must not be blocked, or even partially blocked as this could affect the cabinet's performance and life span.

## **Shelves**

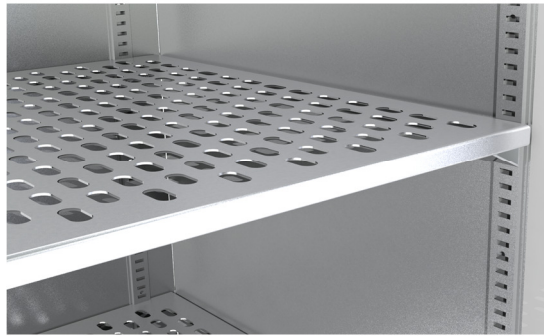

Cut the nylon ties holding the shelves in position for transportation. Fit the shelves in the correct position to suit the user.



## **Adjustable Legs / Levelling Feet**

Models fitted with adjustable legs or levelling feet can be levelled by screwing the legs/feet in or out to the desired height.

## Initial Start Up

Plug the moulded plug into a suitable socket. If necessary, push the  button on the controller to start the unit. The cabinet air temperature will be displayed once the unit is running. To standby the unit when running, press and hold the  button for 3 seconds.

## Checks

After initial startup, after 3-minute time delay the cabinet should start to pull down to the preset temperature, check that the temperature is reducing and listen inside and outside the cabinet to make sure the fans are turning freely to check there has been no movement in shipping. If time permits, stay with the cabinet until the preset temperature is reached and the condensing unit cuts out. The preset temperature can be checked by pressing the  button on the controller.

## Using Your New Piece of Refrigeration Equipment

### Bottle Coolers / Glass Froster

The cabinet must reach its preset operating temperature before loading any produce. Ensure stored products are evenly distributed on shelves ensuring that no more than 40kg are placed on each shelf.

Warm or hot food products should never be stored inside the cabinet.

Food products containing acetic acids or yeast should be covered or ideally stored in airtight containers otherwise premature failure of the refrigeration system may occur.

### Bottle Coolers

Bottle Coolers are designed to store sealed bottle/cans drinks product only (including on the base) and should never be used to store food.

### Glass Froster

Glass Frosters units are designed for the storage of glasses only.



## **Commissioning Instructions**

### **Bottle Coolers +3°C to +15°C\*Glass Froster -18 °C to -22 °C**

#### **Temperature Setting**

Bottle Coolers are designed to operate between +3°C to +15°C but the factory presets the temperature for +3°C.

Glass Fosters are designed to operate between -10°C to -22°C but the factory presets the temperature for -22°C.

The temperature setting can be checked by pressing the  twice to unlock the display. Once unlocked press the  display will show SP This setting can then be changed to better meet site conditions by pressing the + or - arrows and then  to confirm. The temperature set is the cut out (stopping) temperature, the cut in (starting) temperature is determined by the differential.

\* Food should not be stored in this product

.

#### **Defrosting**

Precision refrigerated cabinets are fitted with a fully automated defrost system that ensures the cooling system remains free from ice under normal conditions. If a manual defrost is required, this can be activated by simultaneously pressing  for 3 seconds which will terminate automatically once the pre-programmed temperature has been reached.

#### **Maintenance**

The cabinet is fully automatic and apart from cleaning needs very little maintenance.

Interior and exterior should be cleaned with soap and water and no abrasives should be used as they will scratch and spoil the stainless-steel finish. Interior shelving and racking can be removed on most models for easy cleaning.

## **Maintenance and Cleaning**

Before cleaning and maintenance, the cabinet should be unplugged from the power supply.

Door Gaskets should be cleaned with warm soapy water and inspected on a regular basis and if damaged they should be replaced. Cooking oils and harsh cleaning detergents will shorten the life of the gaskets and contact should be avoided.

## **Condenser Cleaning**

The cabinets use low maintenance condensers. All the heat removed from the cabinet is discharged into the room via the condenser which is similar to a car radiator. This must be kept clean so that the air can pass through it to remove the heat, if it becomes choked with dust the unit will over heat and this can lead to poor cooling performance, increased energy consumption and premature mechanical failure. The condenser should be brushed with a soft brush to remove any dust deposited on the alloy fins. The frequency of this cleaning is determined by the amount of dust in the surrounding area but should be cleaned at least 2 times a year.

## **Gasket Replacement**

Damaged gaskets can easily be replaced. Remove the old gasket by gently pulling it out of the gasket retainer and simply push in the new gasket leaving the corners until last.



## **End of Life Disposable Requirements**

Refrigerated cabinets have components that could be harmful to the environment. All end of life equipment must be disposed of in accordance with national laws and regulations.



## Fault Finding

In the event of cabinet fault/failure, please check the following:

1. Plug is in socket and power to the socket can be proven by plugging another appliance into the same socket or swapping the problem cabinet to a socket that is known to work.
2. The fuse located in the plug is intact.
3. The condenser is clean and free from dust or debris.
4. Door gasket is sealing and free from damage.

If this doesn't solve the problem, please call a qualified technician.

When requesting a service call, please find the manufacturers data plate and provide the model, serial number and details of any fault codes that are displayed.

## Alarms

The controller is equipped with visual and audio alarms:

| Alarm Displayed | Description            | Action Required   |
|-----------------|------------------------|---|
| hi              | High Temperature Alarm | Press a button to cancel / check  |
| Lo              | Low Temperature Alarm  | Press a button to cancel / check  |
| E1              | Probe T1 Failure       | Call Engineer   |
| E2              | Probe T2 Failure       | Call Engineer   |
| OFF             | Cabinet in Standby     | Press  for 3 seconds |

## Controller

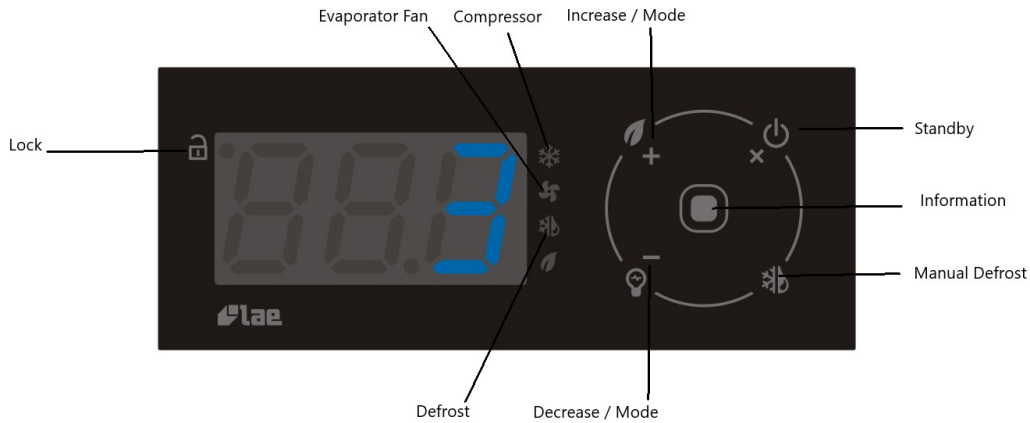

## Wiring Diagram

LAE BD1 Connection Diagram for Bottle Coolers

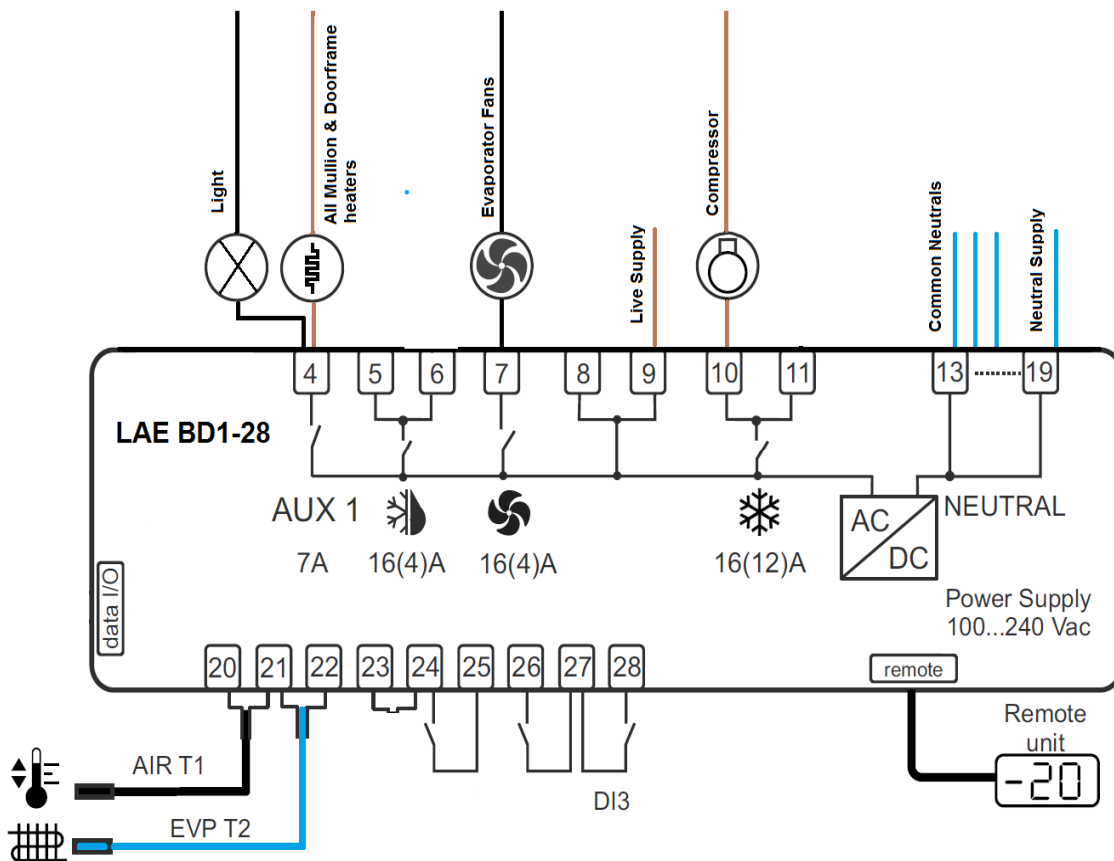



**Model:** .....

**Serial Number:** .....

**GWP Values for Refrigerants:**

R1234Ze - ~ 1

R290 - 3

R134a – 1300

R404a – 3943

These units contain fluorinated greenhouse gases covered by the F Gas directive

**Declaration of Conformity References:**

Low Voltage Directive 2006/95/EC

EC Machinery Directive 2006/42EC

Electromagnetic Compatibility Directive 2004/108/EC

Pressure Equipment Directive 97/23/EC

RoHS / WEE Directive 2002/95 EC

